



RASH

ALNOF

Welcome

Arjan Xhelaj - Maurizio Goretti

RASH Director – NaMeX CEO

Thank you!

- More than **130 registered** attendees from **62 entities**
- **32 local ISPs** (Albania and Kosovo)
- **19 International companies**
- **11 local players (non-ISPs)**

Thanks to the Sponsors!

- GOLD



- SILVER



- Speakers

MIXP, EURO-IX, Facebook, Seeweb, RIPE NCC, ISOC

RASH

- Albanian NREN
- Operational from 2012 – funding from the Italian Cooperation
- 30 employees (90% IT)
- Activities:
 - Connect Albanian public universities to GEANT and to the Internet
 - Provide IT services to universities
 - Software: Student Curricula administration, Finance Office administration, Research Facilities
 - Portals for professors and students
 - Outsourcing of IT Infrastructure : Datacenter dedicated to academy and research
 - Future Services: VoIP between Universities, E-learning

NaMeX IXP Rome

- Founded in 1995
- 1.5 Mln Euro revenue (2016), 7 people
- 80 ISPs
- 50 Gbps traffic peak
- Non-profit (we invest all incomes)
- Member based (no single owner)
- 3 POPs in Rome

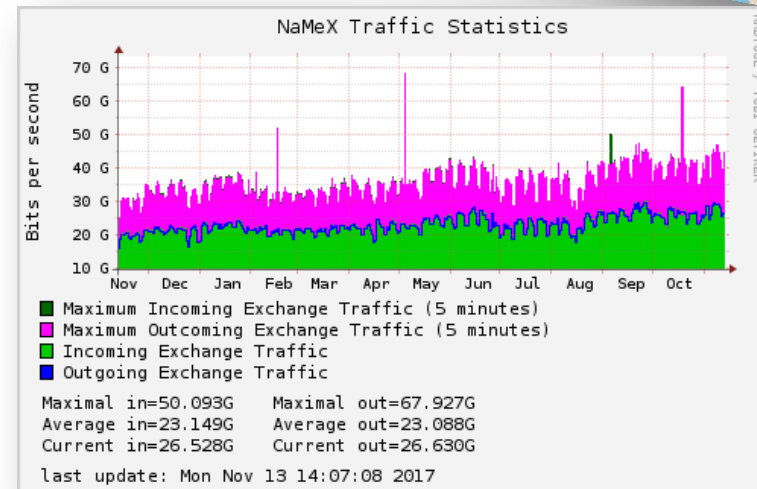
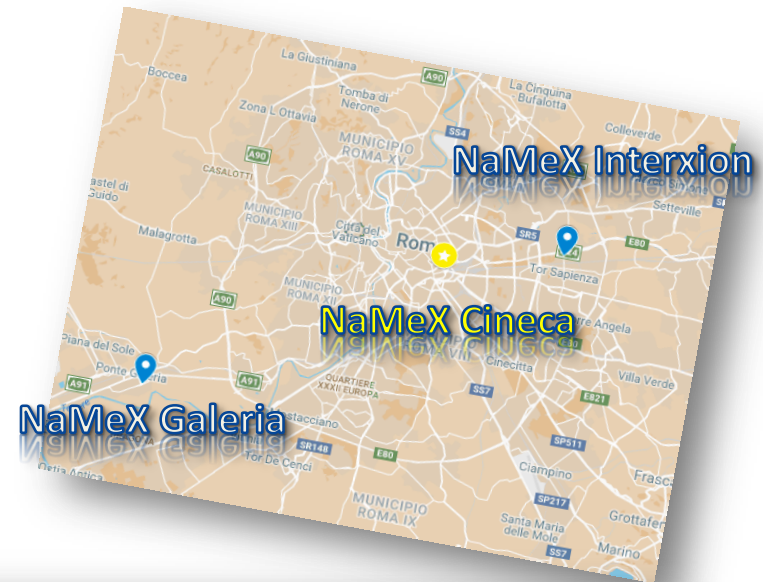

NaMeX



- Interconnection One-Stop-Shop
- Euro-IX Association member
Member of
euro-IX
- Italian ISPs provider (AIIP) member
@iip Associazione Italiana
INTERNET Provider
- Hosting national PA Network IXP – QXN SPC

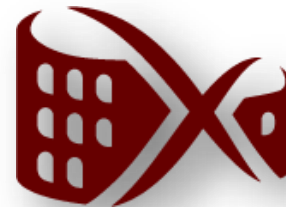
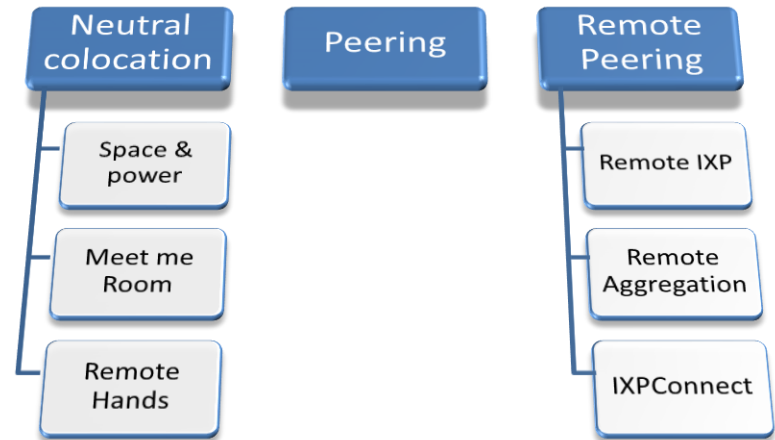

NAMEX
ROMA Internet eXchange Point



NaMeX first steps

✓ March 1995 – 4 ISPs asked, together, one AS to RIPE

✓ They received 4 contiguous ASs

5394 * 5395 * 5396 * 5397

✓ 64 Kbps leased lines

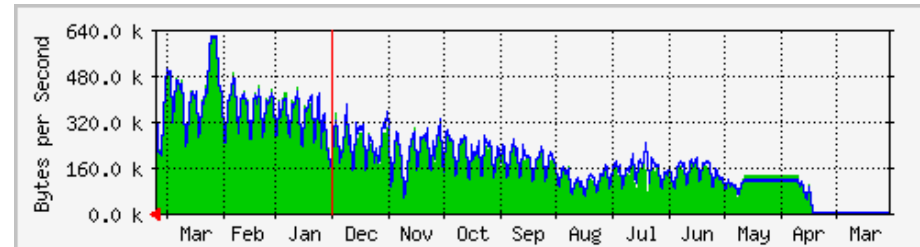

✓ No switch, just RG58 black coaxial cable! (10 Base2)

✓ Every time a new member entered the IXP ... the IXP stopped!

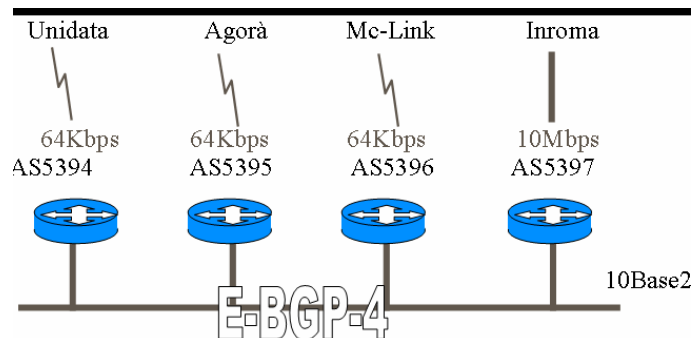

ALNOF goals

- To encourage you, local ISPs, to build a local network community
- To establish a permanent Albanian Network Operator Group (NOG)
- To interconnect to each other

Neutral Internet Exchange Point

ANIX

The logo for ANIX (Albanian Neutral Internet Exchange) features the letters 'ANIX' in a bold, blue, sans-serif font. The letter 'I' is replaced by a blue silhouette of the map of Albania. Above the map is a blue network icon consisting of a central circle connected to four smaller circles by lines.

ALNOF Agenda

Part I: Interconnection

10.10-10.30 Interconnection in Albania and the Albanian Neutral IXP (Daniele Arena, NAMEX)

10.30-10.50 The experience of a regional IXP: MIXP (Božo Krstajić, MIXP)

10.50-11.00 PeeringDB (Bijal Sanghani, Euro-IX)

11.00-11.20 Facebook: network infrastructure and interconnection (Lee Hetherington, Facebook)

11.20-11.30 The transition to IPv6 (Marco d'Itri, Seeweb)

11.30-12.00 Coffee break

ALNOF Agenda

Part II: Networking Community

12.00-12.20 RIPE NCC Services and Activities (Mirjam Kühne, RIPE NCC)

12.20-12.40 Network Operator Groups: What, Why and How – the example of SINOG (Jan Zorz, ISOC)

12.40-13.30 Panel: Interconnection and Networking Community in Albania

13.30-14.30 Lunch

14.30-17.00 BGP Workshop

Interconnect!

- From our experience:
 - ✓ The more ISPs collaborate one to each other, the more the whole Albanian ICT market will increase



We have an opportunity, all together, let's not waste it!

Thanks

Arjan Xhelaj - Maurizio Goretti

RASH Director – NaMeX CEO